

6 - Moduli Elettronici

6 - Electronic Modules

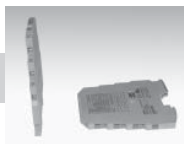

Moduli Conversione Segnali Analogici - Contenitori da 6,1 ... 22,5 mm
Converter Analogic Signal Module - 6,1 ... 22,5 mm Case

6/1



Moduli Trasduttori AC/DC - Contenitore 22,5 mm
AC/DC Transducers Module - 22,5 mm Case

6/5



Moduli Conversione Segnali Analogici - Serie DB28 / EN28K
Converter Analogic Signal Module - DB28 / EN28K Series

6/6



Moduli Condizionamento Termoresistenze - Contenitore da 12,5 mm
Thermal Resistance Converter Module - 12,5 mm Case

6/7



Moduli Condizionamento Temperatura
Thermal Converter Module

6/8



Multiplexer - Analogico/Digitale - Temperatura - Segnali Resistivi
Multiplexer - Analog/Digital - Temperature - Resistors Signals

6/9



Moduli Convertitore Analogico/Digitale 8-12 bit Binario
8-12 bit Analogic/Digital Binary Converter Module

6/10



Moduli Convertitore Digitale/Analogico 8 bit Binario
8 bit Digital/Analogic Binary Converter Module

6/11



Moduli Convertitore RS232 Current Loop 20 mA
20 mA RS232 Current Loop Converter Module

6/12



Moduli Convertitore RS232 / 422-485
RS232 / 422-485 Converter Module

6/13

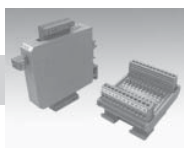

Moduli Diodi
Diodes Module

6/14



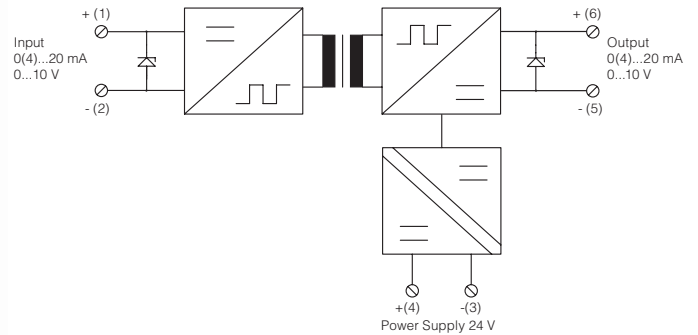

Caratteristiche d'ingresso

Input characteristics

Tensione / Impedenza	Voltage / Impedance	0...10 Vdc / 100 KOhms
Corrente / Impedenza	Current / Impedance	0(4)...20 mA / 50 Ohms

Caratteristiche uscita

Output characteristics

Tensione / Carico	Voltage / Load	0...10 Vdc / ≥ 10 kOhms
Corrente / Carico	Current / Load	0(4)...20 mA / ≤ 500 Ohms
Classe di Errore	Error class	< 0,3 %
Frequenza di Taglio	Cut-off frequency	> 100 Hz - 3 dB

Dati tecnici

Specifications

Tensione ausiliaria	Power supply	24 Vdc $\pm 15\%$, 0,6 W
Isolamento	Insulation	510 VAc
Tensione di Lavoro	Working voltage	100 V
Temperatura di esercizio	Operative temperature	0...+55° C
Temperatura di stoccaggio	Storage temperature	-25...+85° C
Grado di protezione	Enclosure	IP 20
Allacciamento	Connection	Morsetti a vite / Screw terminal blocks
Sezione cavi flessibili	Fine-wired section	max 2,5 mm ²
Montaggio	Mounting	A scatto su profilo / Snap-in mounting on DIN TS32-TS35
Dimensioni L x B x H [mm]	Dimensions L x B x H [mm]	6,1 x 87,9 x 90

Standards e Approvazioni

Standards and Approvals

EMC	EMC	EN61326, Classe B
Approvazioni	Approval	cUL, File No. E 220033, Standards: UL 508 and CAN/CSA 22.2 No. 14

Alimentazione Power Supply	Isolamento Insulation	Tipo Type	Codice Code
24 Vdc	510 VAC	EMIS10U/24C	64EB10000

Settaggi / Setting

Input	Output	S1		S2						
		1	2	1	2	3	4	5	6	
0 to 20 mA	0 to 20 mA	ON					ON			
0 to 20 mA	4 to 20 mA	ON					ON			
0 to 20 mA	0 to 10 V	ON						ON	ON	
4 to 20 mA	0 to 20 mA	ON		ON	ON	ON	ON			
4 to 20 mA	4 to 20 mA	ON					ON			
4 to 20 mA	0 to 10 V	ON		ON	ON	ON	ON			
0 to 10 V	0 to 20 mA		ON				ON	ON		
0 to 10 V	4 to 20 mA		ON				ON	ON		
0 to 10 V	0 to 10 V		ON						ON	ON

Accessori / Accessories

	Tipo Type	Codice Code
Pettine estraibile 41 punti	Pluggable cross-connection 41 points	EPC
		64EZU0542

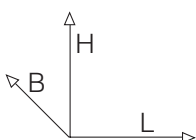

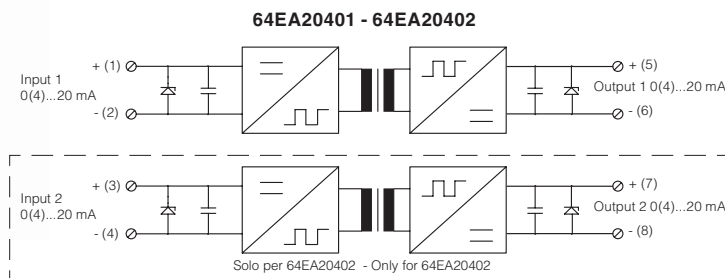
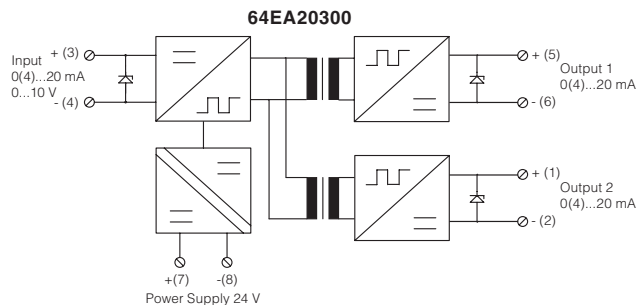

Caratteristiche d'ingresso		Input characteristics		64EA20300	64EA20401	64EA20402
Tensione / Impedenza	Voltage / Impedance			0...10 Vdc / 100 kOhms	/	
Corrente / Impedenza	Current / Impedance			0(4)...20 mA / 50 Ohms (at 0...20mA)	0(4)...20 mA / 50 Ohms (at 0...20mA)	
Canali	Channels			1	1	2
Caratteristiche uscita		Output characteristics				
Tensione / Carico	Voltage / Load			/	/	
Corrente / Carico	Current / Load			0(4)...20 mA / ≤ 10 V (≤ 500 Ohms at 20mA)	0(4)...20 mA / ≤ 12 V (≤ 600 Ohms at 20mA)	
Classe di Errore	Error class			< 0,3 %	< 0,1 %	
Frequenza di Taglio	Cut-off frequency			> 100 Hz	> 100 Hz	
Disturbo residuo	Residual ripple			< 10 mVrms	< 10 mVrms	
Canali	Channels			2	1	2
Dati tecnici		Specifications				
Tensione ausiliaria	Power supply			24 Vdc ±15%, 1,2 W	/	
Isolamento	Insulation			1,5 kVAC in/power - 2,5 kVAC in/out - out/power	2,5 kVAC	
Tensione di Lavoro	Working voltage			300 V		
Temperatura di esercizio	Operative temperature			0...+55° C	-20...+65° C	
Temperatura di stoccaggio	Storage temperature			-25...85° C	-25...85° C	
Grado di protezione	Enclosure			IP 20		
Allacciamento	Connection			Morsetti a vite / Screw terminal blocks		
Sezione cavi flessibili	Fine-wired section			max 2,5 mm ²		
Montaggio	Mounting			A scatto su profilo / Snap-in mounting on DIN TS32-TS35		
Dimensioni L x B x H [mm]	Dimensions L x B x H [mm]			6,2 x 87,9 x 90		
Standards e Approvazioni		Standards and Approvals				
EMC	EMC			EN61326		
Approvazioni	Approval			cURus: File No. E 220033, Standards: UL 508, CAN/CSA 22.2 No. 14-95		

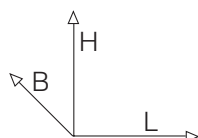

Settaggi / Setting

Input	Output	Switch				
		1	2	3	4	5
0 to 20 mA	0 to 20 mA					ON
0 to 20 mA	4 to 20 mA	ON				ON
4 to 20 mA	0 to 20 mA	ON	ON	ON		ON
4 to 20 mA	4 to 20 mA					ON
0 to 10 V	0 to 20 mA					ON
0 to 10 V	4 to 20 mA	ON				ON

Alimentazione Power Supply	Isolamento Insulation	Tipo Type	Codice Code
24 Vdc	1,5 kVAC in/pwr - 2,5 kVAC in/out - out/pwr	EMIS11/20/24C	64EA20300
/	2,5 kVAC	EMIS11/10	64EA20401
/	2,5 kVAC	EMIS21/20	64EA20402

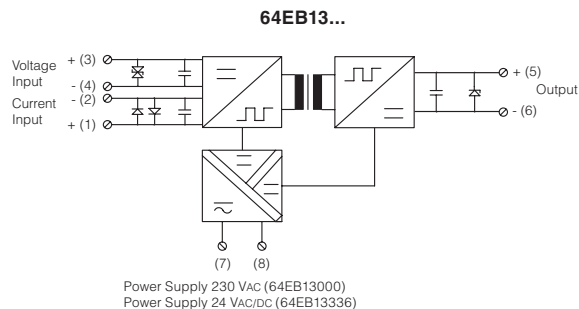
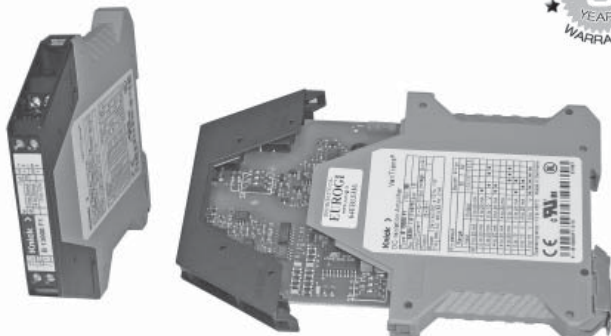

Caratteristiche d'ingresso		Input characteristics		64EB13000	64EB13336
Tensione / Impedenza	Voltage / Impedance	0...10 Vdc / 1 MOhms			
Corrente / Impedenza	Current / Impedance	0(4)...20 mA / 50 Ohms (at 0...20mA)			
Caratteristiche uscita		Output characteristics			
Tensione / Carico	Voltage / Load	0...10 Vdc / ≤ 10 mA (1 kOhm at 10V)			
Corrente / Carico	Current / Load	0(4)...20 mA / ≤ 10 V (500 Ohms at 20mA)			
Classe di Errore	Error class	< 0,4 %			
Frequenza di Taglio	Cut-off frequency	> 1 kHz - 3 dB			
Disturbo residuo	Residual ripple	< 20 mVrms			
Dati tecnici		Specifications			
Tensione ausiliaria	Power supply	230 Vac -15%, +10%, 48...62 Hz, 2 VA	24 Vac/dc;	ac ±15% 48...62 Hz, 2 VA dc ±15%, 0,9 W	
Isolamento	Insulation	3,25 kVAC			
Tensione di Lavoro	Working voltage	600 V			
Temperatura di esercizio	Operative temperature	-10...+60° C			
Temperatura di stoccaggio	Storage temperature	-25...+85° C			
Grado di protezione	Enclosure	IP 20			
Allacciamento	Connection	Morsetti a vite / Screw terminal blocks			
Sezione cavi flessibili	Fine-wired section	max 2,5 mm ²			
Montaggio	Mounting	A scatto su profilo / Snap-in mounting on DIN TS32-TS35			
Dimensioni L x B x H [mm]	Dimensions L x B x H [mm]	12,5 x 99 x 111			
Standards e Approvazioni		Standards and Approvals			
EMC	EMC	EMC 89/336/EEC, EN61326			
Approvazioni	Approval	cUL: File No. E 216767, Standards: UL 3101-1, CSA-C 22.2 No. 10101-1 GL : No. 14627-99 HH			
Prova di Surge	Surge withstand	5 kV 1,2/50 μs to IEC 255-4			

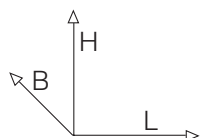

Settaggi / Setting							
Input	Output	S1			S2		
		1	2	3	1	2	3
0 to 20 mA	0 to 20 mA						
0 to 20 mA	4 to 20 mA	ON					
0 to 20 mA	0 to 10 V		ON		ON	ON	
4 to 20 mA	0 to 20 mA	ON	ON				
4 to 20 mA	4 to 20 mA						
4 to 20 mA	0 to 10 V				ON	ON	ON
0 to 10 V	0 to 20 mA	ON			ON		
0 to 10 V	4 to 20 mA				ON		
0 to 10 V	0 to 10 V	ON	ON	ON	ON	ON	ON

Alimentazione Power Supply	Isolamento Insulation	Tipo Type	Codice Code
230 Vac	3,25 kVAC	EMIS60U/230A	64EB13000
24 Vac/dc	3,25 kVAC	EMIS60U/24A/C	64EB13336

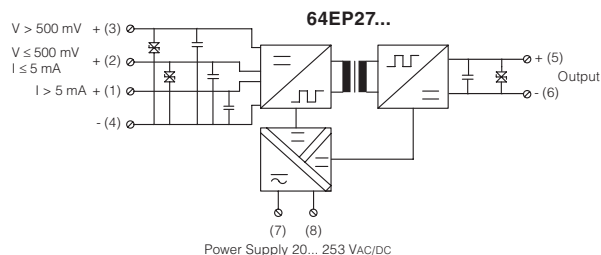
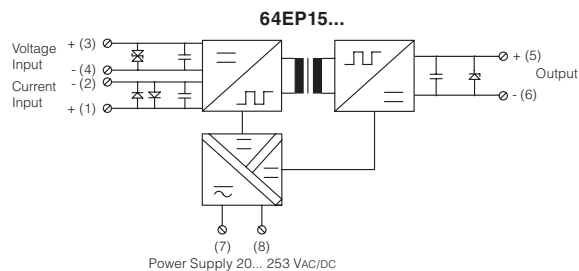
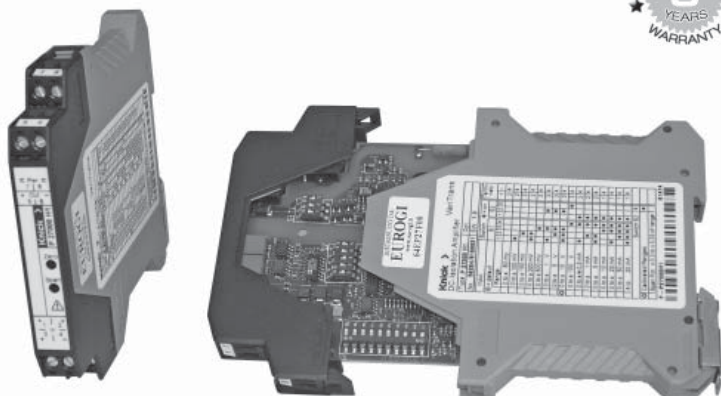

Caratteristiche d'ingresso		Input characteristics		64EP1500		64EP2700	
Tensione / Impedenza	Voltage / Impedance	0...10 Vdc / 1 MOhms		0...±20 mV (200V) / 1 MOhms			
Corrente / Impedenza	Current / Impedance	0(4)...20 mA / 50 Ohms (at 0...20mA)		0...±0,1(100) mA / 50 Ohms (at 0...±20mA)			
Caratteristiche uscita		Output characteristics					
Tensione / Carico	Voltage / Load	0...10 Vdc / ≤ 10 mA (1 kOhm at 10V)		0...(±)10 Vdc / ≤ 10 mA (1 kOhm at 10V)			
Corrente / Carico	Current / Load	0(4)...20 mA / ≤ 12 V (600 Ohms at 20mA)		0(4)...(±)20 mA / ≤ 12 V (600 Ohms at 20mA)			
Classe di Errore	Error class	< 0,08 %		< 0,08 %			
Frequenza di Taglio	Cut-off frequency	> 10 kHz; switchable to < 10 Hz - 3 dB		> 10 kHz; switchable to < 10 Hz - 3 dB			
Disturbo residuo	Residual ripple	< 10 mVrms		< 10 mVrms			
Dati tecnici		Specifications					
Tensione ausiliaria	Power supply	20...253 Vac/dc;		ac 48...62 Hz, 2 VA		dc 0,9 W	
Isolamento	Insulation	4 kVAC		5 kVAC in/out, 4 kVAC out/power			
Tensione di Lavoro	Working voltage			1000			
Temperatura di esercizio	Operative temperature			-10...+70° C			
Temperatura di stoccaggio	Storage temperature			-40...+85° C			
Grado di protezione	Enclosure			IP 20			
Allacciamento	Connection			Morsetti a vite / Screw terminal blocks			
Sezione cavi flessibili	Fine-wired section			max 2,5 mm ²			
Montaggio	Mounting			A scatto su profilo / Snap-in mounting on DIN TS32-TS35			
Dimensioni L x B x H [mm]	Dimensions L x B x H [mm]			12,5 x 99 x 111			
Standards e Approvazioni		Standards and Approvals					
EMC	EMC			EN61326			
Approvazioni	Approval			cUL: File No. E 216767, Standards: UL 3101-1, CSA-C 22.2 No. 10101-1			
				GL : No. 14593-99 HH		GL : No. 42 843-02 HH	
Prova di Surge	Surge withstand			5 kV 1,2/50 µs to IEC 255-4			

Input	Output	S1			S2		
		1	2	3	1	2	3
0 to 20 mA	0 to 20 mA						X
0 to 20 mA	4 to 20 mA	ON					X
0 to 20 mA	0 to 10 V		ON		ON	ON	X
4 to 20 mA	0 to 20 mA	ON	ON				ON
4 to 20 mA	4 to 20 mA						X
4 to 20 mA	0 to 10 V			ON	ON	ON	X
0 to 10 V	0 to 20 mA	ON					X
0 to 10 V	4 to 20 mA		ON	ON			X
0 to 10 V	0 to 10 V	ON	ON	ON	ON	ON	X
Bandwidth 10 Hz		X	X	X	X	X	ON
Bandwidth 10 kHz		X	X	X	X	X	

X - non influenza il settaggio - without influence on this setting

Settaggi / Setting

Input	S1				S2			
	1	2	3	4	1	2	3	4
0 to ± 60 mV								ON
0 to ± 100 mV	ON							ON
0 to ± 150 mV		ON						ON
0 to ± 300 mV	ON	ON						ON
0 to ± 500 mV			ON					ON
0 to ± 1 V	ON		ON				ON	ON
0 to ± 5 V		ON	ON				ON	ON
0 to ± 10 V	ON	ON	ON				ON	ON
0 to ± 100 V				ON				ON
0 to ± 0,3 mA	ON				ON	ON		ON
0 to ± 1 mA		ON			ON	ON		ON
0 to ± 5 mA	ON	ON			ON	ON		ON
0 to ± 10 mA			ON	ON	ON	ON		ON
0 to ± 20 mA	ON		ON	ON	ON	ON		ON
0 to ± 50 mA		ON	ON	ON	ON	ON		ON
4 to 20 mA	ON	ON	ON	ON	ON	ON		ON

Switch S2		4
Calibrated ranges		ON
Span potentiometer : 0,33 ... 3,30 x end of range		

* Offset switch-over not calibrated

Output	S1			S3	
	5	6	7	1	2
0 to ± 10 V				ON	ON
2 to 10 V	ON			ON	ON
0 to ± 5 V		ON		ON	ON
1 to 5 V	ON	ON		ON	ON
0 to ± 20 mA			ON		
4 to 20 mA	ON		ON		
Offset	S1			S2	
(in % of output span)	8	9	10	5	
0 %				ON	
-100 %	ON			ON	
-50 %		ON		ON	
+50 %			ON	ON	
-100 %			ON	ON	
Zero potentiometer : additional ± 25 %					
				Switch S3	
Bandwidth 10 kHz					3
Bandwidth 10 Hz					ON

Alimentazione Power Supply	Isolamento Insulation	Tipo Type	Codice Code
20...253 Vac/dc	4 kVAC	EMIS100U/20-253VA/C	64EP1500
20...253 Vac/dc	5 kVAC in/out - 4 kVAC out/power	EMIS100RU/20-253VA/C	64EP2700

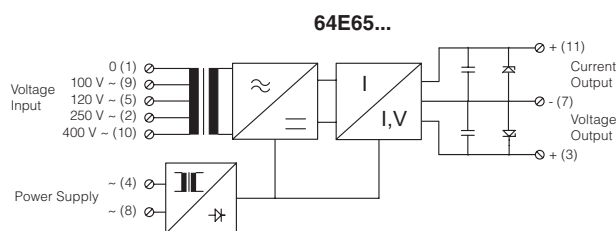
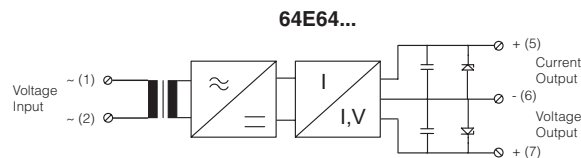
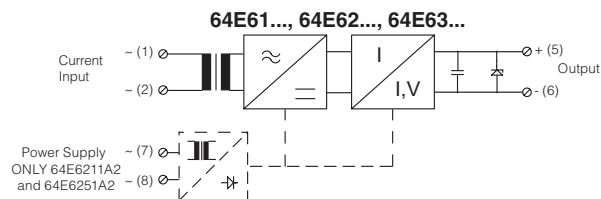

Caratteristiche d'ingresso		Input characteristics	64E61..., 64E62..., 64E63...	64E64..., 64E65...
Tensione	Voltage		/	0...400 V
Corrente	Current		0...5 A	/
Caratteristiche uscita		Output characteristics		
Tensione / Carico	Voltage / Load		0...10 Vdc / ≤ 5 mA (2 kOhm at 10V)	0(2)...10 Vdc / ≤ 10 mA (1 kOhm at 10V)
Corrente / Carico	Current / Load		0(4)...20 mA / ≤ 15 V (750 Ohms at 20mA)	0(4)...20 mA / ≤ 12 V (600 Ohms at 20mA)
Classe di Errore	Error class		< 0,5 %	< 0,5 %
Dati tecnici		Specifications		
Tensione ausiliaria	Power supply		230 Vac -15%, +10% 47...63 Hz, 1,5 VA (only 64E62... and 64E65...)	
Isolamento	Insulation		6 kVAC, 4 kVAC see table	
Temperatura di esercizio	Operative temperature		-10...+70° C	
Temperatura di stoccaggio	Storage temperature		-30...+80° C	
Grado di protezione	Enclosure		IP 20	
Allacciamento	Connection		Morsetti a vite / Screw terminal blocks	
Sezione cavi flessibili	Fine-wired section		max 2,5 mm ²	
Montaggio	Mounting		A scatto su profilo / Snap-in mounting on DIN TS32-TS35	
Dimensioni L x B x H [mm]	Dimensions L x B x H [mm]		22,5 x 89 x 99	
Standards e Approvazioni		Standards and Approvals		
EMC	EMC		EN61326	
Prova di Surge	Surge withstand		5 kV 1,2/50 μs to IEC 255-4	

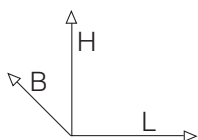

Ingresso Input	Uscita Output	Alimentazione Power Supply	Isolamento Insulation	Tipo Type	Codice Code
0...1 A	0...20 mA	/	6 kVAC	ETR61A20	64E6111A2
0...1 A	4...20 mA	230 Vac	6 kVAC in/out - in/pwr 4 kVAC out/pwr	ETR61A04/230A	64E6211A2
0...1 A	0...10 V	/	6 kVAC	ETR61A10	64E6311A2
0...5 A	0...20 mA	/	6 kVAC	ETR65A20	64E6151A2
0...5 A	4...20 mA	230 Vac	6 kVAC in/out - in/pwr 4 kVAC out/pwr	ETR65A04/230A	64E6251A2
0...5 A	0...10 V	/	6 kVAC	ETR65A10	64E6351A2
0...100/120 V	0...20 mA/0...10 V	/	4 kVAC	ETR6120V1020	64E6472A2
0...250/400 V	0...20 mA/0...10 V	/	4 kVAC	ETR6400V1020	64E6482A2
0...100/120/250/400 V	0(4)...20 mA/0(2)...10 V	230 Vac	4 kVAC	ETR6S	64E6502A2

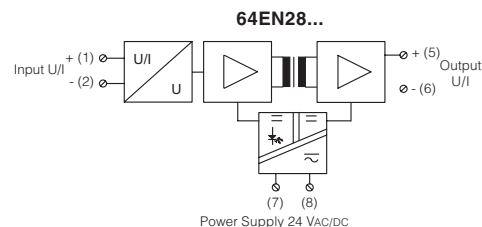
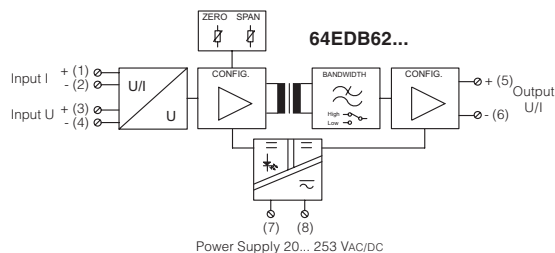

Caratteristiche d'ingresso		Input characteristics		64EDB62...		64EN28K...	
Tensione / Impedenza	Voltage / Impedance	0...±10 Vdc (switch select.) / 1 MOhms		0...10 V / 1 MOhms			
Corrente / Impedenza	Current / Impedance	0(4)...±20 mA (switch select.) / 25 Ohms		0(4)...20 mA / 5 Ohms			
Caratteristiche uscita		Output characteristics					
Tensione / Carico	Voltage / Load	0...±10 Vdc / ≤ 10 mA (1 kOhm at 10V)		0...10 Vdc / ≥ 2 kOhm			
Corrente / Carico	Current / Load	0(4)...±20 mA / ≤ 12 V (600 Ohms at 20mA)		0(4)...20 mA / ≤ 500 Ohms			
Classe di Errore	Error class	< 0,1 % of final value		< 0,2 % of final value			
Frequenza di Taglio	Cut-off frequency	> 10 kHz; switchable to < 30 Hz					
Disturbo residuo	Residual ripple	< 20 mVrms		< 10 mVrms			
Dati tecnici		Specifications					
Tensione ausiliaria	Power supply	20...253 Vac/dc; ac 48...62 Hz, 2 VA dc 1 W		24 Vac/dc ±15%; ac 48...62 Hz, 2 VA dc 0,7 W			
Isolamento	Insulation	4 kVAC		2,5 kVAC			
Tensione di Lavoro	Working voltage	1000 V		600 V			
Temperatura di esercizio	Operative temperature	-20...+70° C		-0...+55° C			
Temperatura di stoccaggio	Storage temperature	-35...+85° C		-25...+80° C			
Grado di protezione	Enclosure	IP 20					
Allacciamento	Connection	Morsetti estraibili / Pluggable terminal blocks		Morsetti a vite / Screw terminal blocks			
Sezione cavi flessibili	Fine-wired section	max 2,5 mm ²					
Montaggio	Mounting	A scatto su profilo / Snap-in mounting on DIN TS32-TS35					
Dimensioni L x B x H [mm]	Dimensions L x B x H [mm]	12,5 x 99 x 111		11,2 x 60 x 67			
Standards e Approvazioni		Standards and Approvals					
EMC	EMC			EN61326			

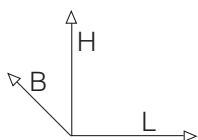

Ingresso Input	Uscita Output	Alimentazione Power Supply	Isolamento Insulation	Tipo Type	Codice Code
±10 V, 0(2)...10 V, ±5 V, 0(1)...5 V ±20 mA, 0(4)...20 mA, ±10 mA, 0(4)...10 mA (selez. tramite DIP Switch / switch select.)	±10 V, 0(2)...10 V, ±5 V, 0(1)...5 V ±20 mA, 0(4)...20 mA, ±10 mA, 0(4)...10 mA (selez. tramite DIP Switch / switch select.)	20...230 Vac/dc	4 kVAC	EMIS±10V±10V/20253VA/C	64EDB6200
0(4)...20 mA	0(4)...20 mA	24 Vac/dc	2,5 kVAC	EMIS020020/24A/C	64EN28K12
0...10 V	4...20 mA	24 Vac/dc	2,5 kVAC	EMIS010420/24A/C	64EN28K54
4...20 mA	0...10 V	24 Vac/dc	2,5 kVAC	EMIS420010/24A/C	64EN28K36

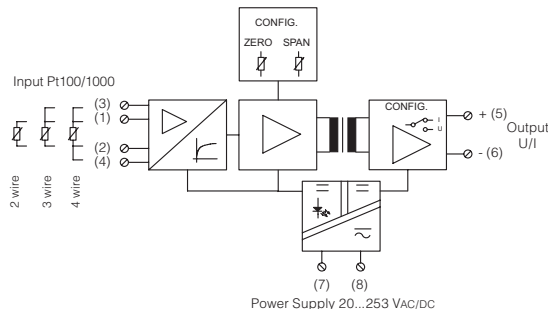

Caratteristiche d'ingresso

Input characteristics

Segnale di ingresso	Input signal	Pt100 / Pt1000 (selezionabile, switchable)
Connessione / Resist. filo	Connection / Wire resist.	2-wire, 3-wire, 4-wire / < 10 Ohms (for wire)
Corrente sensore	Sensor current	1 mA / 0,1 mA (for Pt1000)
Diagnostica	Diagnostic	Sensore, filo interrotto / Sensor, wire break

Caratteristiche uscita

Output characteristics

Tensione / Carico	Voltage / Load	0...10 V / ≤ 5 mA (2 kOhms at 10 V)
Corrente / Carico	Current / Load	0(4)..20 mA (selezionabile, switchable) / ≤ 10 V (500 Ohms at 20 mA)
Disturbo residuo	Ripple	< 10 mVrms
Errore sensore	Sensor break action	Uscite in corrente / Current output ≥ 22 mA - Uscite in tensione / Voltage output ≥ 11 V

Dati tecnici

Specifications

Tensione ausiliaria	Power supply	20...253 Vac/dc, ac 48...62 Hz, 3 VA - dc 1,5 W
Linearità	Linearity	< 0,2 % of span
Coeff. di temperatura	Temperature coefficient	< 0,01° C/Kamb. + 0,02 %/K del valore finale / of final value
Calibrazione	Calibration	± 0,1° C
Tempo di risposta	Response time	< 50 ms
Isolamento	Insulation	2,5 kVAC, 50 Hz
Tensione di Lavoro	Working voltage	600 V
Temperatura di esercizio	Operative temperature	-10...+60° C
Temperatura di stoccaggio	Storage temperature	-20...+80° C
Grado di protezione	Enclosure	IP 20
Allacciamento	Connection	Morsetti a vite / Screw terminal blocks
Sezione cavi flessibili	Fine-wired section	max 2,5 mm ²
Montaggio	Mounting	A scatto su profilo / Snap-in mounting on DIN TS32-TS35
Dimensioni L x B x H [mm]	Dimensions L x B x H [mm]	12,5 x 99 x 111

Standards e Approvazioni

Standards and Approvals

EMC	EMC	EN61326-1
-----	-----	-----------

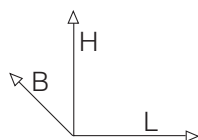

Settaggi / Setting

Input	Switch 1			
	1	2	3	4
2-wire	ON	ON	ON	
3-wire		ON	ON	
4-wire			ON	
Pt100				ON
Pt1000				

Ingresso Input	Uscita Output	Tipo Type	Codice Code
0...100° C	0...10 V	EMPT100V/20253VA/C	64EDR4701
0...200° C	0...10 V	EMPT200V/20253VA/C	64EDR4702
0...100° C	4...20 mA	EMPT100I/20253VA/C	64EDR4703
0...200° C	4...20 mA	EMPT200I/20253VA/C	64EDR4704

Per altre tarature (-50...+500° C) contattare la Sede per prezzi e quantitativi minimi.
Please contact us for different calibration (-50...+500° C) for price and minimal quantity.

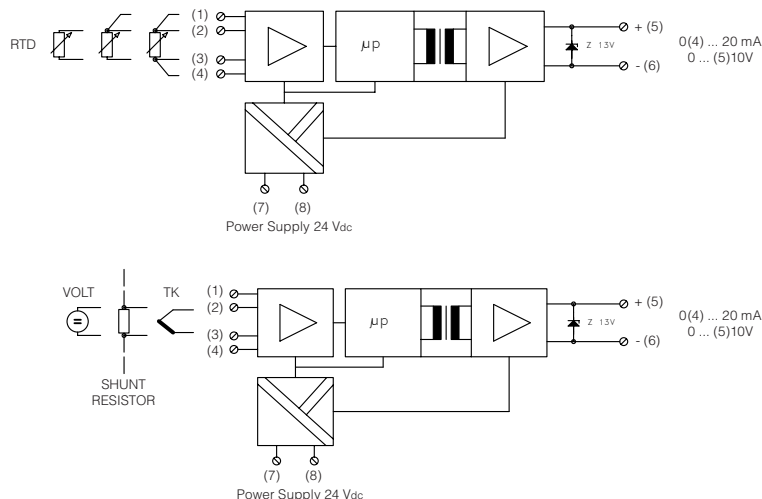
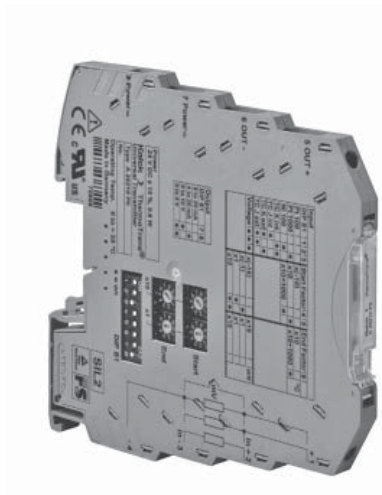

Caratteristiche d'ingresso		Input characteristics	
Ingresso termoresistenza		Resistance thermometers input	
PT100	PT100	-200...+850° C	
PT1000	PT1000	-200...+850° C	
NI100	NI100	-60...+180° C	
Connessione	Connection	2, 3, 4 Fili / Wire	
Massima resistenza di linea	Max line resistance	100 Ohm	
Alimentazione in Corrente	Supply current	200 µA, 400 µA, 500 µA	
Coeff. di temperatura d'ingresso	Temperature coefficient input	< 50ppm/K (Temp. 23° C)	
Ingresso termocoppia		Thermocouples input	
Tipo J	Type J	-210...+1200° C	
Tipo K	Type K	-200...+1375° C	
Resistenza d'ingresso	Input resistance	> 10 MOhm	
Massima resistenza di linea	Max line resistance	1 KOhm	
Limite di errore d'ingresso	Input error line	± 10 µV +5%	
Coeff. di temperatura d'ingresso	Temperature coefficient input	< 50ppm/K (Temp. 23° C)	
Ingresso shunt di tensione		Shunt voltages input	
Ingresso	Input	-1000...+1000 mV	
Resistenza d'ingresso	Input resistance	> 10 MOhm	
Limite di errore d'ingresso	Input error line	± 200 µV +0.05%	
Coeff. di temperatura d'ingresso	Temperature coefficient input	< 50ppm/K (Temp. 23° C)	
Caratteristiche uscita		Output characteristics	
Uscita	Output	0...20 mA, 4...20 mA, 0...5 V, 0...10 V	
Risoluzione	Resolution	16 bits	
Carico	Load	< 500 Ohm at 20 mA / 10 KOhm at 10V	
Limite di errore d'uscita	Output error line	± 10 µA / ± 5 µV	
Residuo ripple	Residual ripple	< 10 mV	
Coeff. di temperatura d'uscita	Temperature coefficient Output	< 50ppm/K (Temp. 23° C)	
Dati generali		General data	
Alimentazione	Power supply	24 Vdc (-20%, +25%) 1,2 W	
Isolamento galvanico	Galvanic isolation	Ingresso/Uscita/Alimentazione / Input/Output/Supply	
Test in tensione	Test voltage	2,5 kVac, 50 Hz	
Tensione di Lavoro	Working voltage	300 Vac-dc	
Montaggio	Mounting	A scatto su profilo / Snap-in mounting on DIN TS32-TS35	
Dimensioni L x B x H [mm]	Dimensions L x B x H [mm]	6,1 x 93 x 111	
Segnalazioni		Display	
Alimentazione	Power supply	Led verde / Green led	
Tipo di connessione	Connection type	Led giallo / Yellow led	
Errore	Device failure	Led rosso / Red led	
Approvazioni		Standards and approvals	
Protezioni esplosioni	Explosion protection	ATEX Zone 2 (EN60079-15) - (UL1604)	
EMC	EMC	EN61326, Class B	
cURus	cURus	File n. 220033 Standard : UL508, CAN/CSA 22.2	

Tipo	Codice
Type	Code
EMPTKJU/24C	64EA20210

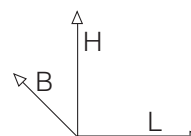

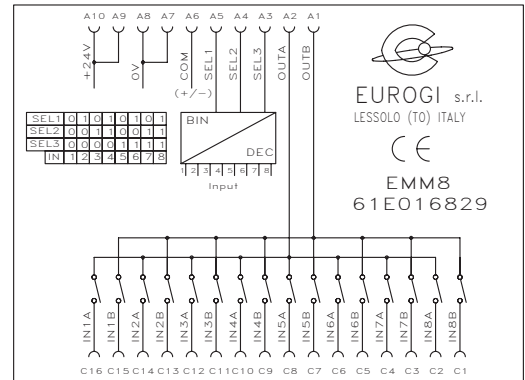

Ingressi / Uscite	Input / Output
RTDs	RTDS
TC	TC
PTC, NTC	PTC, NTC
Ohm	Ohm
V	V
A	A
Conversione	Conversion

PT100, PT1000, NI100 (2 fili / wires)
B, E, J, K, L, N, R, S, T, U

Dati tecnici	Specifications
Tensione ausiliaria	Power supply
Corrente assorbita	Absorbed current
Segnali digitale	digital signal
Tempo di risposta	Response time
Durata meccanica	Endurance mechanical
Tensione min. commutabile	Min switching voltage
Corrente min. commutabile	Min switching current
Resistenza di contatto	Contact resistance
Temperatura di esercizio	Operative temperature
Temperatura di stoccaggio	Storage temperature
Grado di protezione	Enclosure
Allacciamento	Connection
Sezione cavi flessibili	Fine-wired section
Montaggio	Mounting
Dimensioni L x B x H [mm]	Dimensions L x B x H [mm]

24 Vdc ± 10%
100 mA
24 Vdc ± 10% Pnp/Npn
4 mSec. Max
50.000.000 Operazioni / Operations
100 µV
10 µA
75 mOhm
0...+50° C
-25...+70° C
IP 20
Morsetti estraibili / Pluggable terminal blocks
max 2,5 mm²
A scatto su profilo / Snap-in mounting on DIN TS32-TS35
22,5 x 120 x 112

Selezione ingressi Input Selection			
S1	S2	S3	Canale Channel
0	0	0	IN1
1	0	0	IN2
0	1	0	IN3
1	1	0	IN4
0	0	1	IN5
1	0	1	IN6
0	1	1	IN7
1	1	1	IN8

Tipo Type	Codice Code
EMM8/C	61E016829

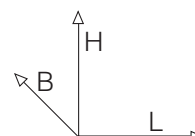

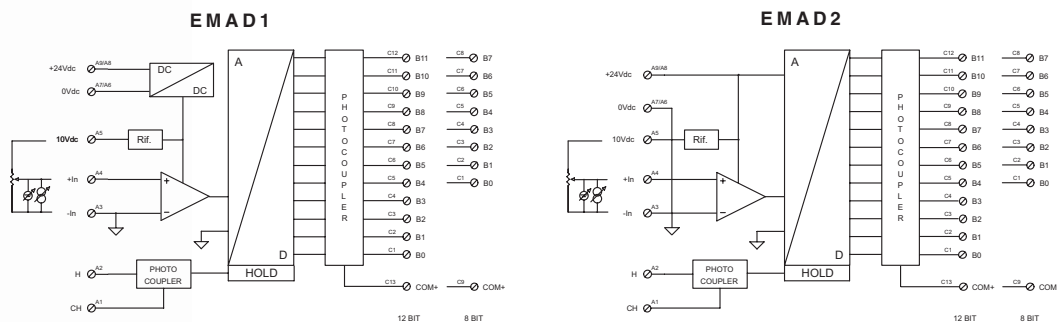

Caratteristiche d'ingresso		Input characteristics		EMAD 1	EMAD 2
Tensione / Impedenza	Voltage / Impedance	0... ± 10 Vdc / > 1 MOhm			
Comando hold	Hold command	24 Vdc / 5 mA			
Caratteristiche uscita		Output characteristics			
Tensione / Carico	Voltage / Load	PNP 24 Vdc / 50 mA			
Isolamento	Insulation	4 KVAc			
Tempo risposta 10...90 %	Response time 10...90 %	10 mSec.			
Memorizzazione uscite (hold)	Output memorization (hold)	0,1 mSec.			
Classe di Errore	Error class	± ½ LSB			
Dati tecnici		Specifications			
Tensione ausiliaria	Power supply	20...35 Vdc, 100 mA	24 Vdc ± 10%, 100 mA		
Isolamento	Insulation	500 Vac	/		
Temperatura di esercizio	Operative temperature	0...+50° C			
Temperatura di stoccaggio	Storage temperature	-25...+70° C			
Grado di protezione	Enclosure	IP 20			
Allacciamento	Connection	Morsetti estraibili / Pluggable terminal blocks			
Sezione cavi flessibili	Fine-wired section	max 2,5 mm ²			
Montaggio	Mounting	A scatto su profilo / Snap-in mounting on DIN TS32-TS35			
Dimensioni L x B x H [mm]	Dimensions L x B x H [mm]	22,5 x 113 x 100			

Con isolamento With insulation			
Ingresso Input	Uscita Output	Tipo Type	Codice Code
0...10 Vdc	8 BIT	EMAD108/010	61E024980

Senza isolamento Without insulation			
Ingresso Input	Uscita Output	Tipo Type	Codice Code
0...10 Vdc	8 BIT	EMAD208/010	61E024990
0...10 Vdc	12 BIT	EMAD212/010	61E024995

Per ingresso in corrente contattare la sede.

Please contact us for input current.

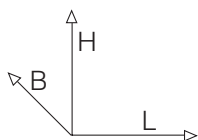

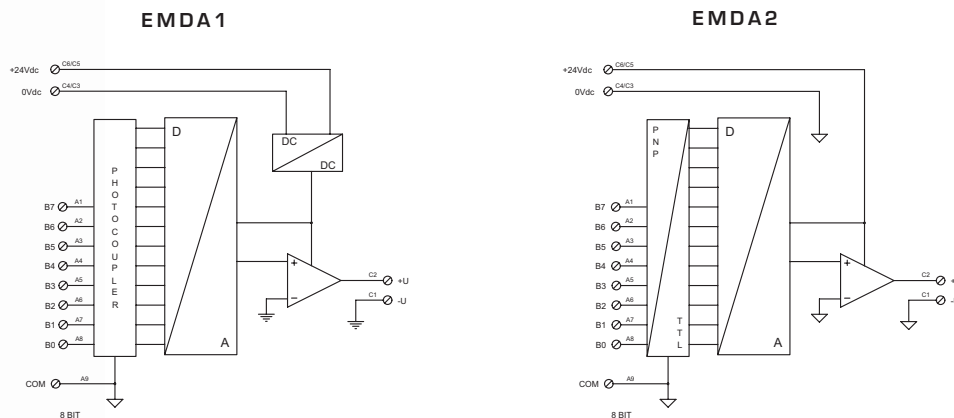

Caratteristiche d'ingresso	Input characteristics	EMDA 1	EMDA 2
Tensione / Carico	Voltage / Load	PNP 24 Vdc / 5 mA	PNP 24 Vdc / 5 mA
Isolamento	Insulation	500 VAC	/
Caratteristiche uscita	Output characteristics		
Tensione / Impedenza	Voltage / Impedance	0...± 10 Vdc / 20 mA	
Tempo risposta 10...90 %	Response time 10...90 %	10 mSec.	
Classe di Errore	Error class	± 1/2 LSB	
Dati tecnici	Specifications		
Tensione ausiliaria	Power supply	20...35 Vdc	24 Vdc ± 10%
Corrente assorbita	Absorbed current	100 mA	100 mA
Isolamento	Insulation	500 VAC	/
Temperatura di esercizio	Operative temperature	0...+50° C	
Temperatura di stoccaggio	Storage temperature	-25...+70° C	
Grado di protezione	Enclosure	IP 20	
Allacciamento	Connection	Morsetti estraibili / Pluggable terminal blocks	
Sezione cavi flessibili	Fine-wired section	max 2,5 mm ²	
Montaggio	Mounting	A scatto su profilo / Snap-in mounting on DIN TS32-TS35	
Dimensioni L x B x H [mm]	Dimensions L x B x H [mm]	22,5 x 113 x 100	

Con isolamento With insulation			
Ingresso Input	Uscita Output	Tipo Type	Codice Code
8 BIT	0...10 Vdc	EMDA108/010	61E025000

Senza isolamento Without insulation			
Ingresso Input	Uscita Output	Tipo Type	Codice Code
8 BIT	0...10 Vdc	EMDA208/010	61E025010

Per uscita in corrente contattare la sede.

Please contact us for output current.

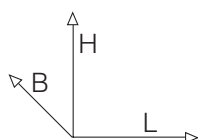

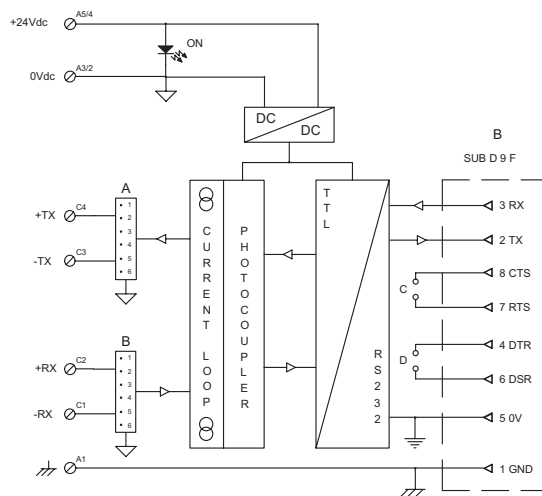

Caratteristiche d'ingresso

Input characteristics

Segnale	Signal	Standard RS232
Velocità trasmissione	Baud Rate	110...19200 Baud

Caratteristiche uscita

Output characteristics

Segnale	Signal	20 mA
Massima distanza	Max. distance	400 m

Dati tecnici

Specifications

Tensione ausiliaria	Power supply	20...35 Vdc, 100 mA
Isolamento	Insulation	500 VAC
Temperatura di esercizio	Operative temperature	0...+50° C
Temperatura di stoccaggio	Storage temperature	-25...+70° C
Grado di protezione	Enclosure	IP 20
Allacciamento	Connection	Morsetti estraibili / Pluggable terminal blocks Connettore SUB-D 9 femmina / SUB-D 9 Female connector
Sezione cavi flessibili	Fine-wired section	max 2,5 mm ²
Montaggio	Mounting	A scatto su profilo / Snap-in mounting on DIN TS32-TS35
Dimensioni L x B x H [mm]	Dimensions L x B x H [mm]	22,5 x 113 x 100

Segnale Signal	JP	Attivo Active	Passivo Inactive
TX	A	1-2 3-4 5-6	2-3 4-5
RX	B	1-2 3-4 5-6	2-3 4-5
DSR	C	ON	OFF
DTR	C	ON	OFF
RTS	D	ON	OFF
CTS	D	ON	OFF

Tipo Type	Codice Code
EMRC24/C	61E016769

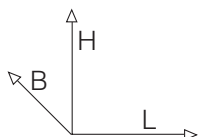

EMR232/.../C



EMR232/...M

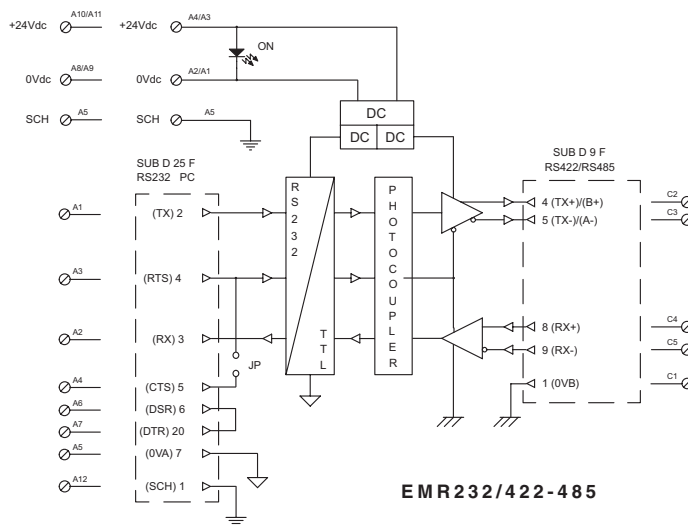

Caratteristiche d'ingresso

Input characteristics

Segnale	Signal	Standard RS232
Velocità trasmissione	Baud Rate	110...19200 Baud

Caratteristiche uscita

Output characteristics

Segnale	Signal	RS422-RS485 Half duplex
Massima distanza	Max. distance	400 m

Dati tecnici

Specifications

Tensione ausiliaria	Power supply	20...35 Vdc, 100 mA
Isolamento	Insulation	500 VAC
Temperatura di esercizio	Operative temperature	0...+50° C
Temperatura di stoccaggio	Storage temperature	-25...+70° C
Grado di protezione	Enclosure	IP 20
Allacciamento	Connection	Morsetti estraibili / Pluggable terminal blocks Connettore SUB-D 9-25 femmina / SUB-D 9-25 Female connector max 2,5 mm ²
Sezione cavi flessibili	Fine-wired section	A scatto su profilo / Snap-in mounting on DIN TS32-TS35
Montaggio	Mounting	
Dimensioni L x B x H [mm]	Dimensions L x B x H [mm]	22,5 x 113 x 100

RS232/422

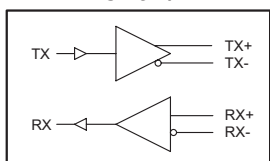

- SW1 - OFF
- SW2 - ON
- SW3 - OFF
- SW4 - OFF
- SW5 - ON
- SW6 - ON
- SW7 - ON

RS232/422 RTS

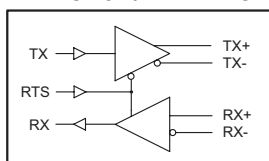

- SW1 - ON
- SW2 - OFF
- SW3 - ON
- SW4 - ON
- SW5 - ON
- SW6 - ON
- SW7 - ON

RS232/485 RTS

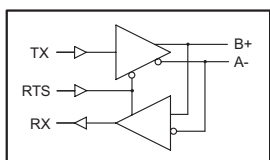

- SW1 - ON
- SW2 - ON
- SW3 - OFF
- SW4 - ON
- SW5 - OFF
- SW6 - ON

RS232/485 ECO

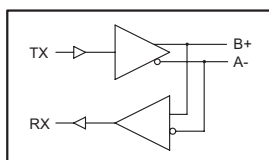

- SW1 - OFF
- SW2 - OFF
- SW3 - ON
- SW4 - ON
- SW5 - OFF
- SW6 - ON

IN RS232	OUT RS422-485	Tipo Type	Code Code
SUB-D 25F	SUB-D 9F	EMR232/422/C	61E016762
SUB-D 25F	SUB-D 9F	EMR232/485/C	61E016763
M	M	EMR232/422M	61E016764
M	M	EMR232/485M	61E016765

M = Morsetti estraibili / Pluggable terminal blocks

SW7 Resistenza di terminazione su TX / Resistance ending on TX
SW8 Resistenza di terminazione su RX / Resistance ending on RX

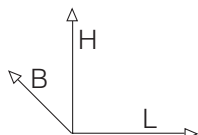

EMD.../C

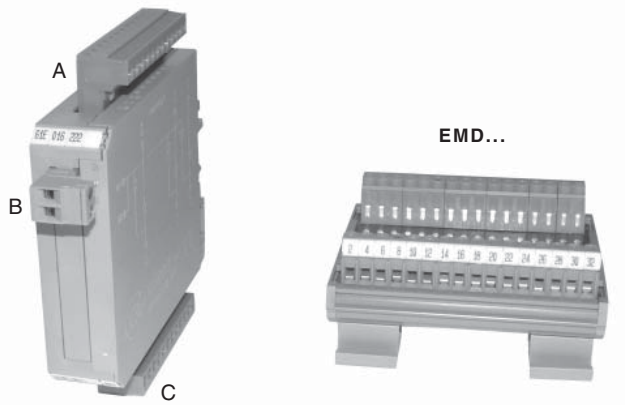

EMD11I

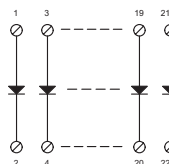

EMD22N

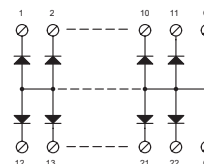

Dati tecnici	Specifications	EMD...	EMD.../C
Tensione max. lavoro	Max. work voltage		250 V
Tensione inversa	Inverted voltage		1000 V
Corrente max.	Max. current		1 A - 3 A
Temperatura di esercizio	Operative temperature		0...+50° C
Grado di protezione	Enclosure	IP 00	IP 20
Allacciamento	Connection	Morsetti a vite / Screw terminal blocks	Morsetti estr. / Pluggable term.blocks
Sezione cavi flessibili	Fine-wired section	max 1,5 mm ²	max 2,5 mm ²
Montaggio	Mounting	A scatto su profilo / Snap-in mounting on DIN TS32-TS35	

EMD24

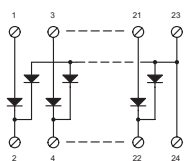

EMD12I/C

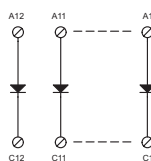

Tipo Type	Codice Code	Dim. [mm] L x B x H	Versione Version
EMD24	61E016233	68 x 82 x 45	22 Diodi prova lampade / 22 Testing lamps diodes
EMD22	61E016230	68 x 82 x 45	22 Diodi catodo comune / 22 Common cathode diodes
EMD22N	61E016231	68 x 82 x 45	22 Diodi anodo comune / 22 Common anode diodes
EMD16I	61E016234	90 x 82 x 45	16 Diodi indipendenti / 16 Independent diodes
EMD11I	61E016232	68 x 82 x 45	11 Diodi indipendenti / 11 Independent diodes
EMD11	61E016240	45 x 82 x 45	11 Diodi catodo comune / 11 Common cathode diodes
EMD11N	61E016241	45 x 82 x 45	11 Diodi anodo comune / 11 Common anode diodes
EMD5I	61E016242	45 x 82 x 45	5 Diodi indipendenti / 5 Independent diodes
EMD5I/3A	61E016243	45 x 82 x 45	5 Diodi indipendenti 3 A / 5 Independent diodes 3 A
EMD11I/3A	61E016244	68 x 82 x 45	11 Diodi indipendenti 3 A / 11 Independent diodes 3 A
EMD8I/C	61E016206	22,5 x 113 x 100	8 Diodi indipendenti / 8 Independent diodes
EMD12I/C	61E016207	22,5 x 113 x 100	12 Diodi indipendenti / 12 Independent diodes

